

一般男子単 (MS)

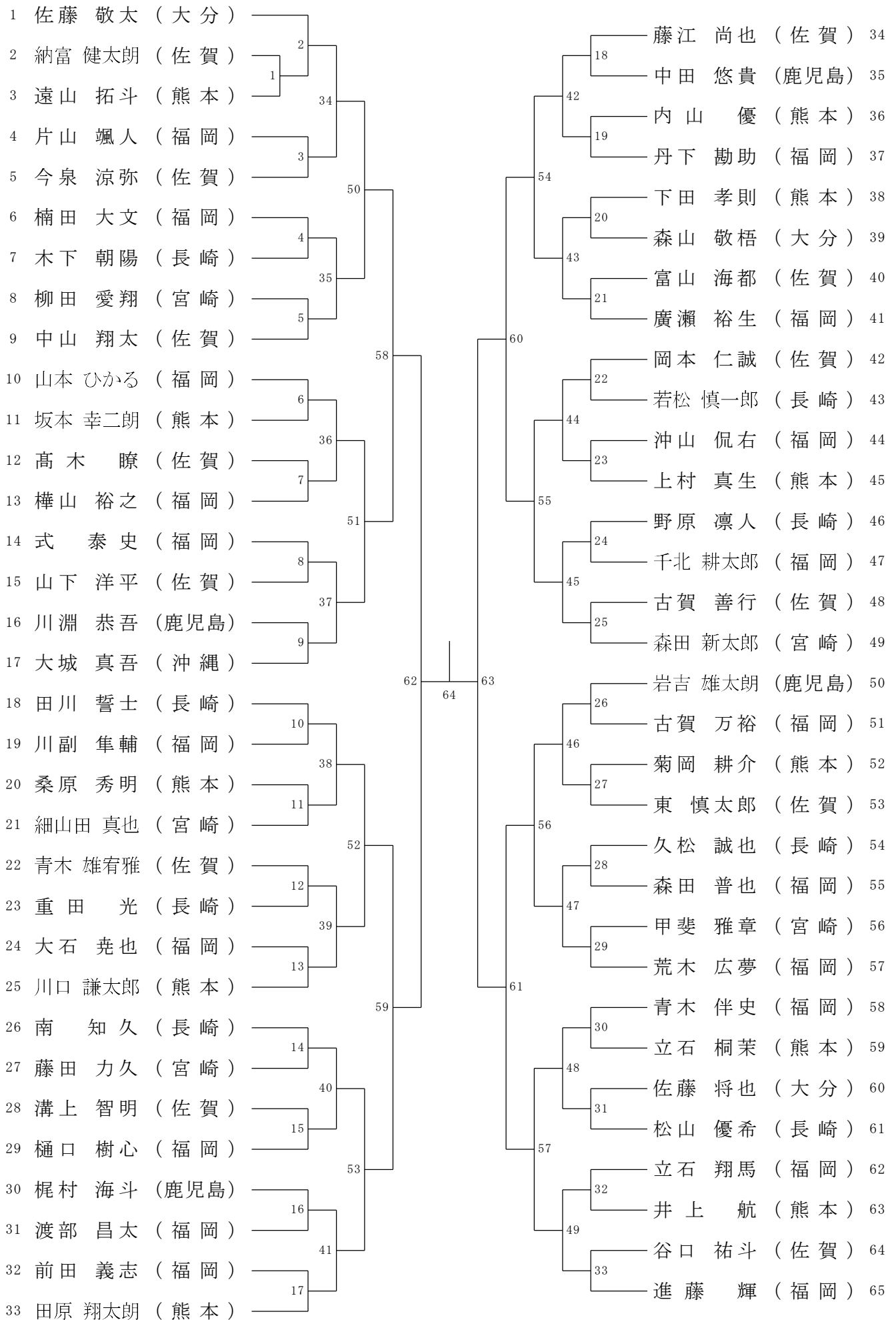

30歳以上男子単 (30MS)

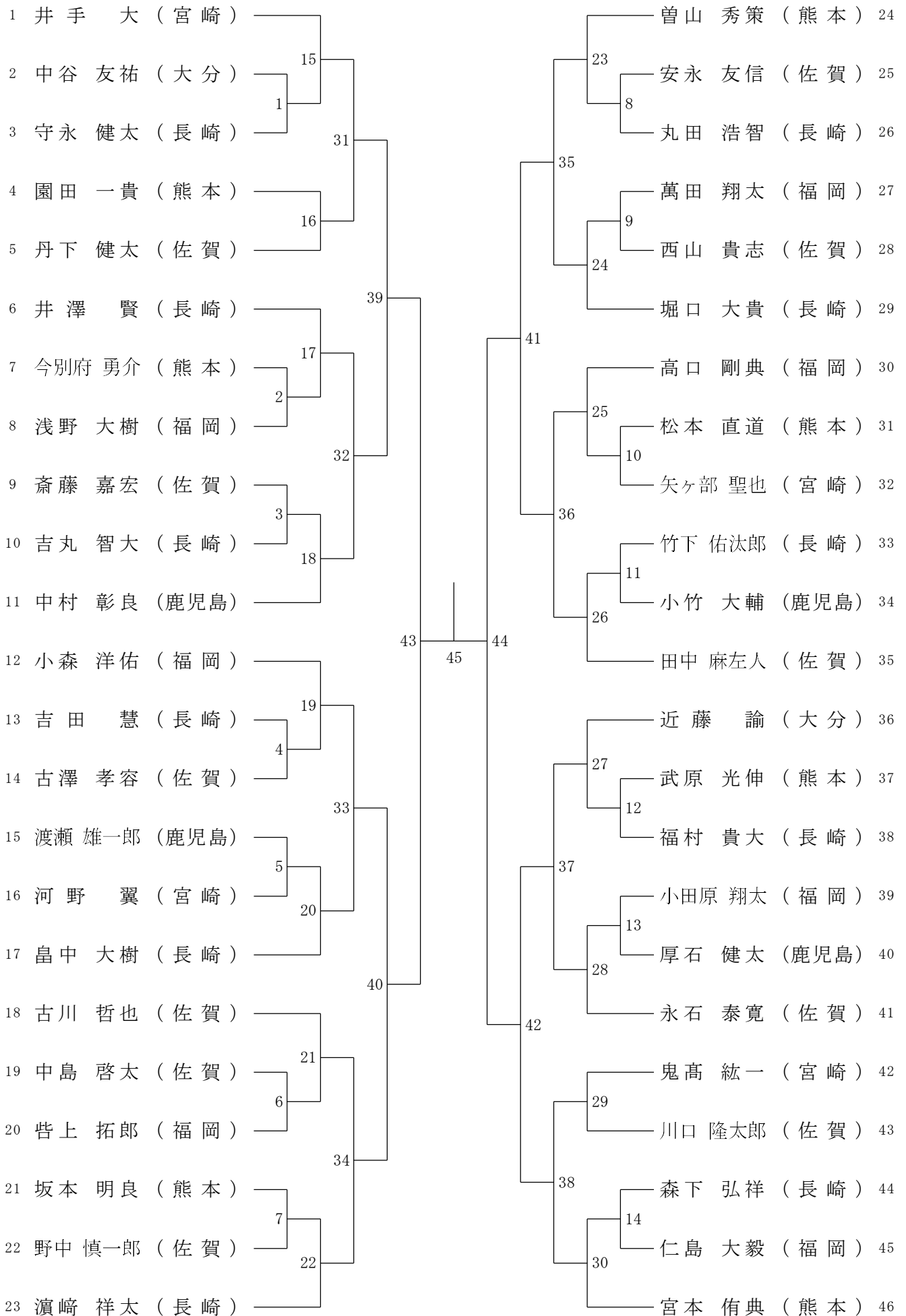

40歳以上男子単 (40MS)

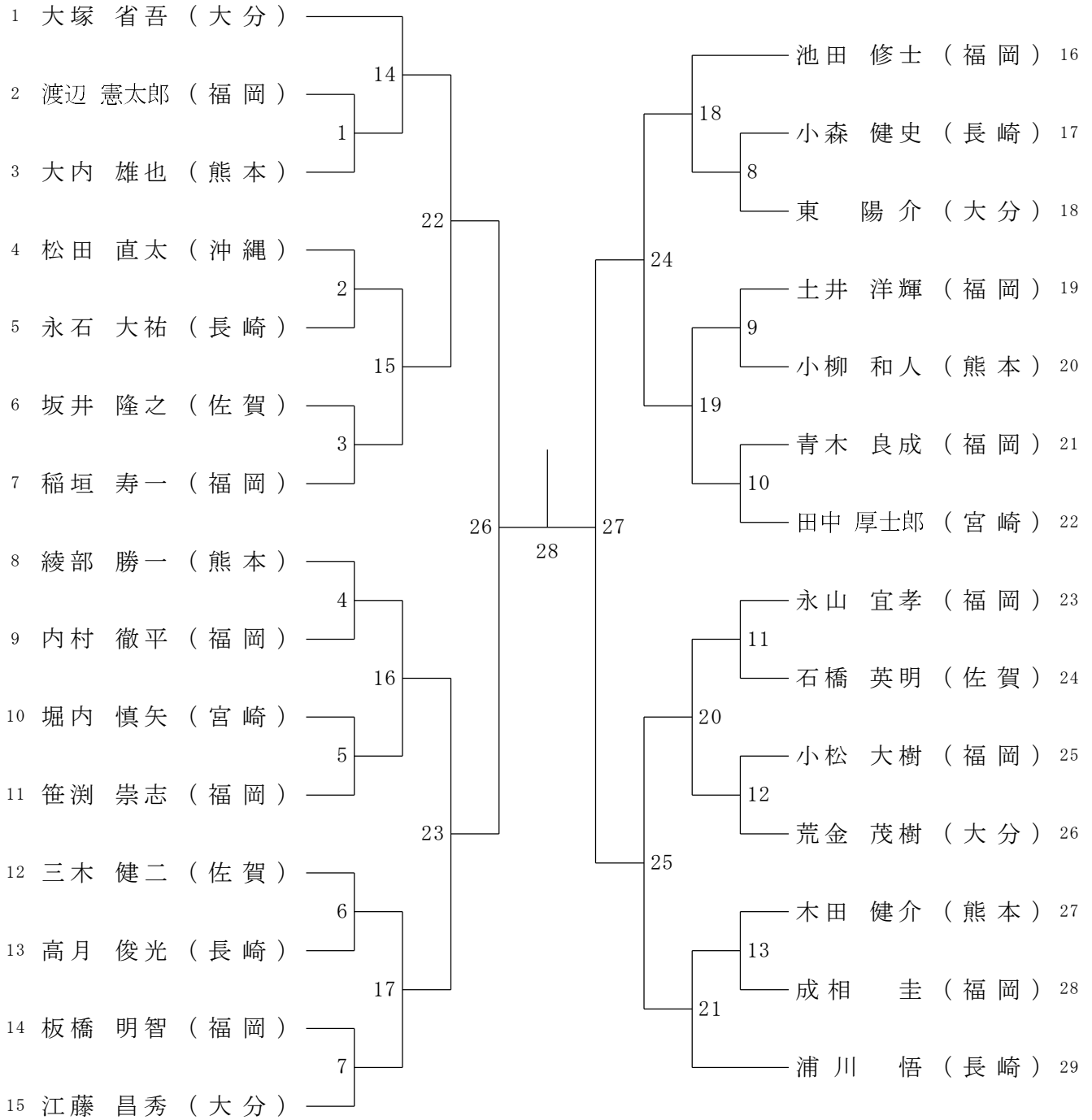

50歳以上男子単 (50MS)

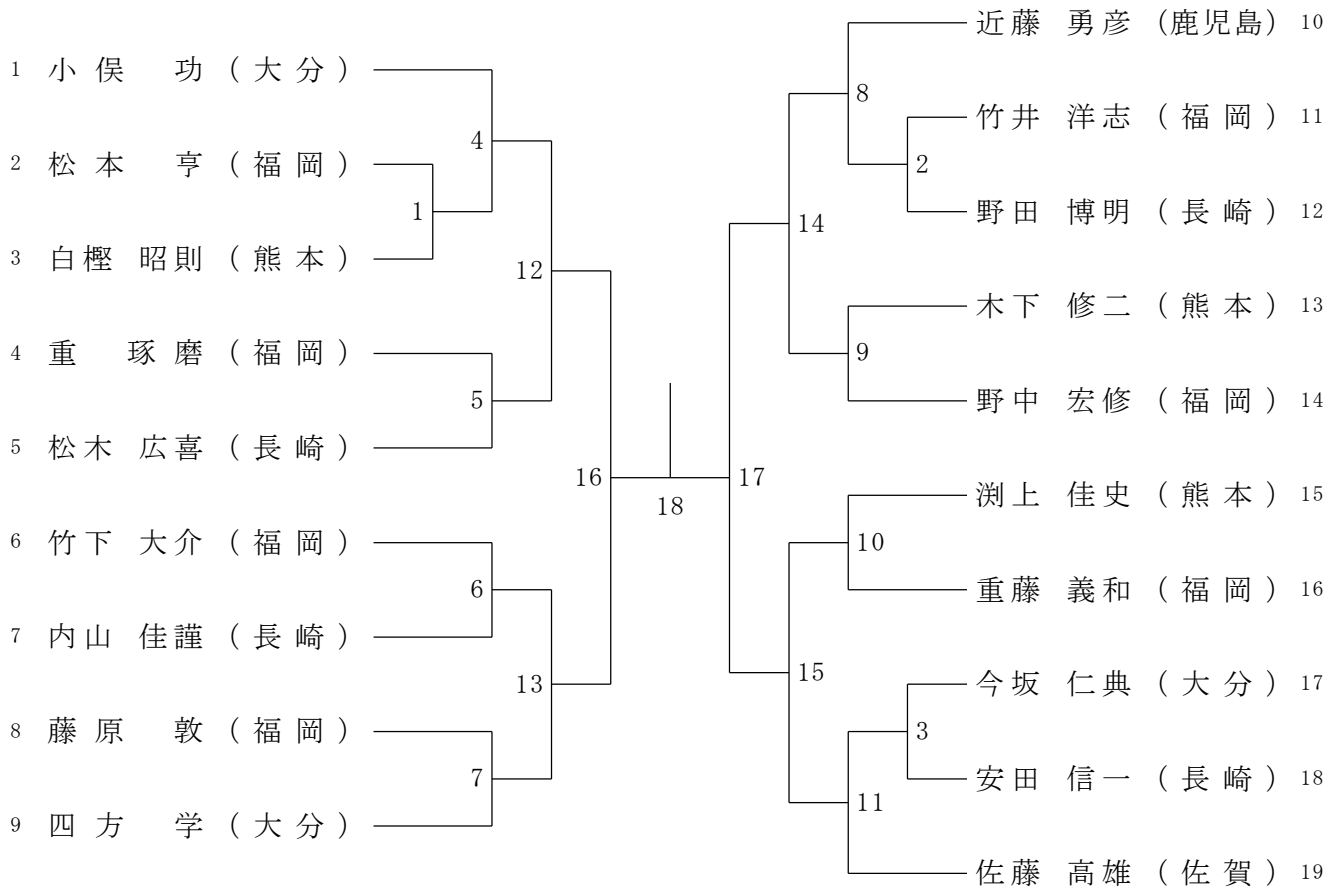

55歳以上男子単 (55MS)

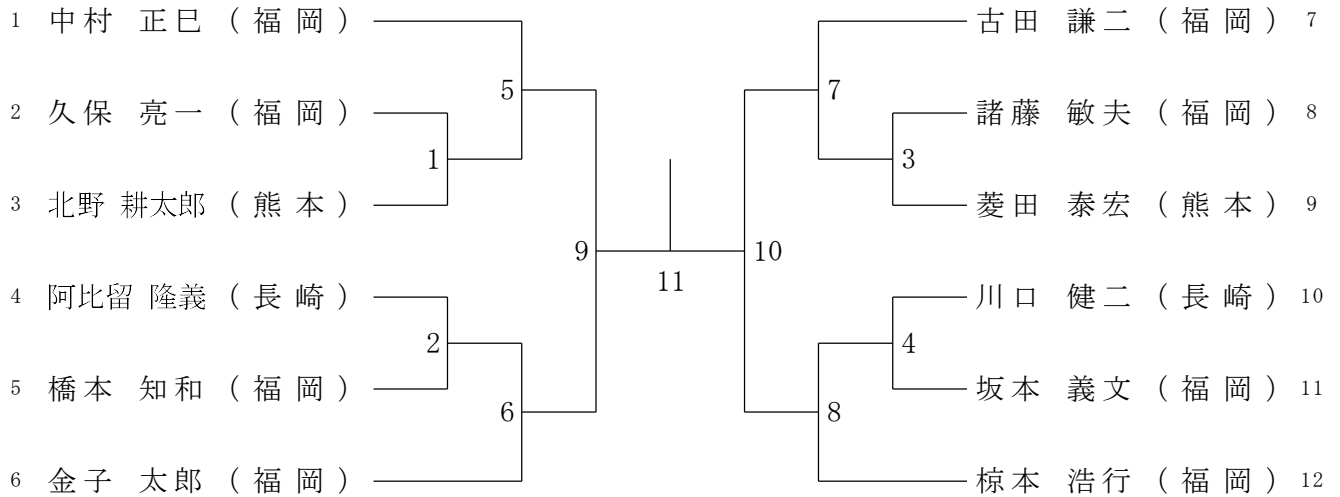

60歳以上男子単 (60MS)

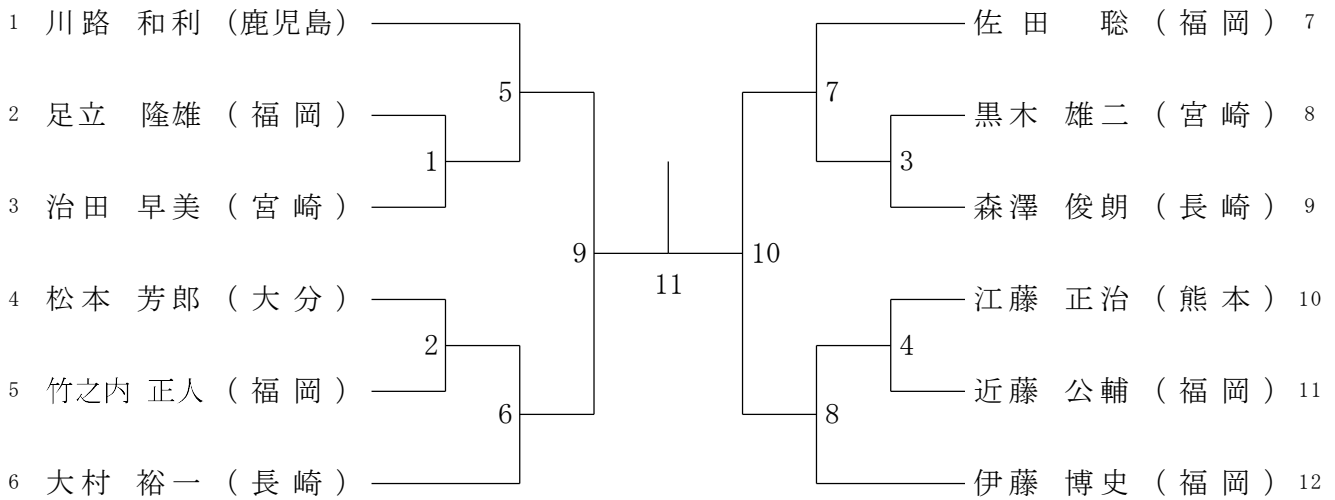

65歳以上男子単 (65MS)

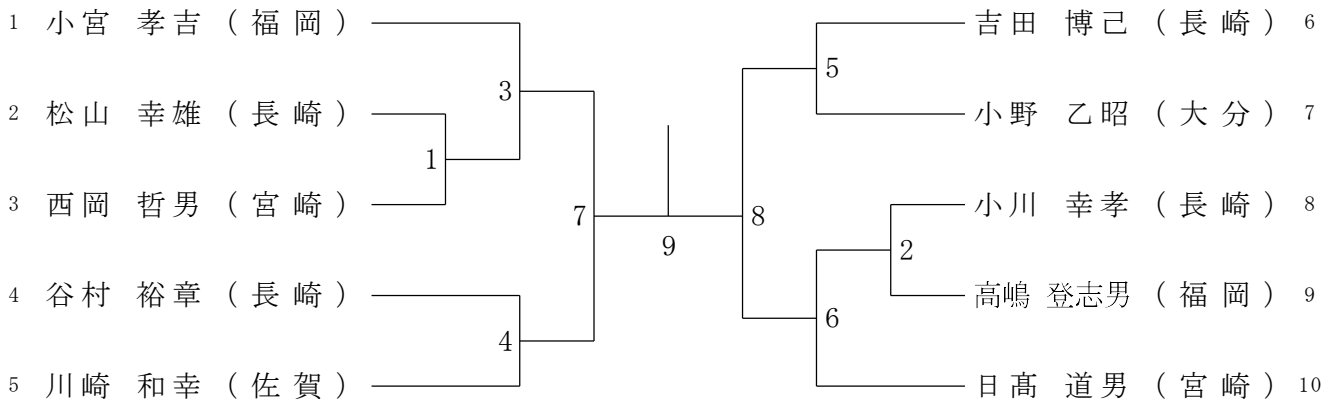

70歳以上男子単 (70MS)

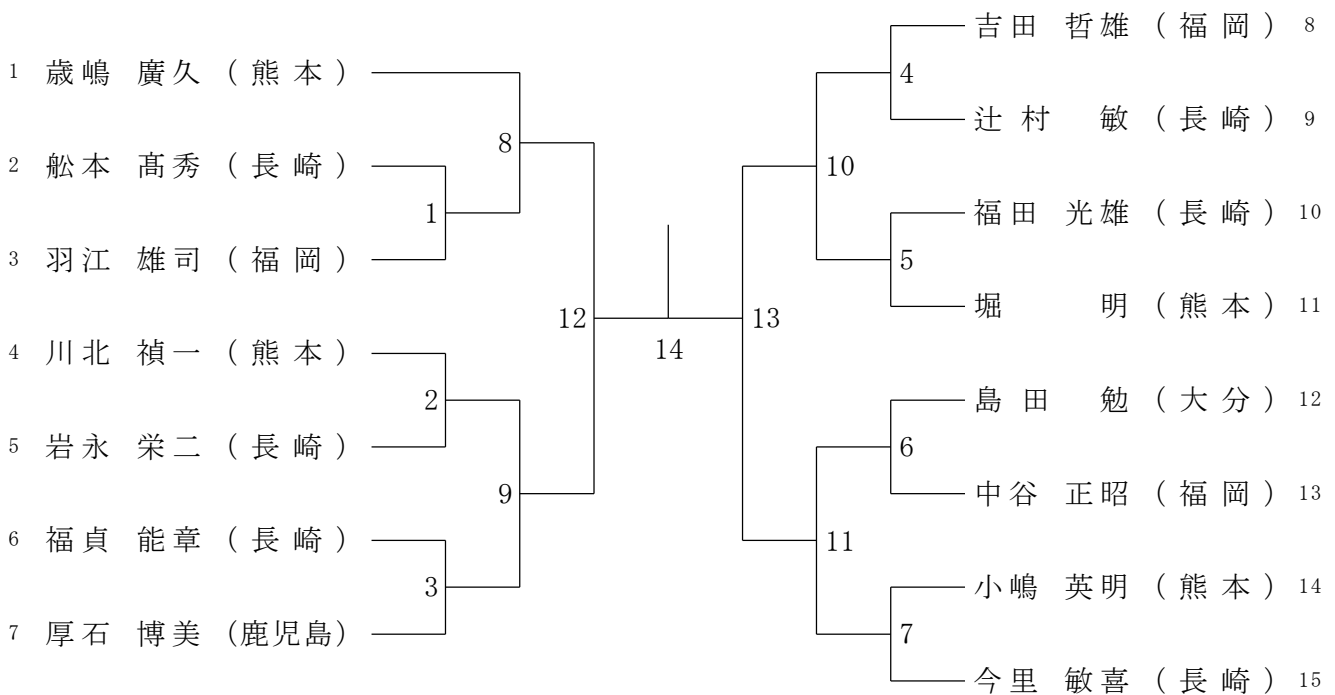

一般女子単 (WS)

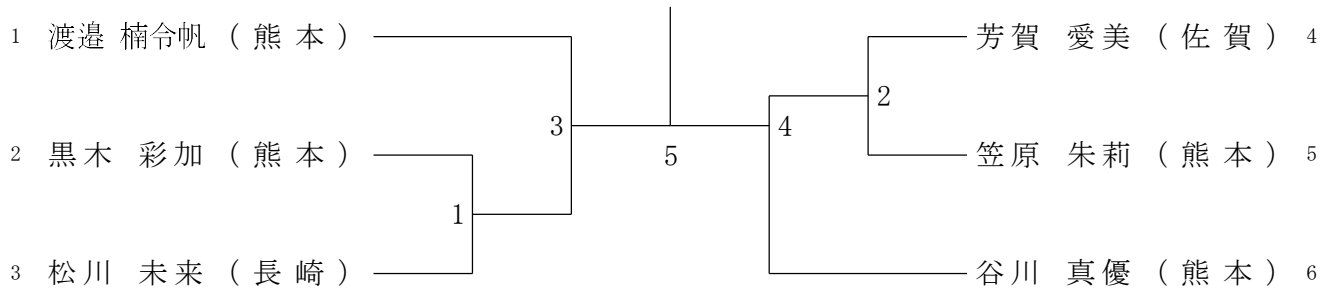

30歳以上女子単 (30WS)

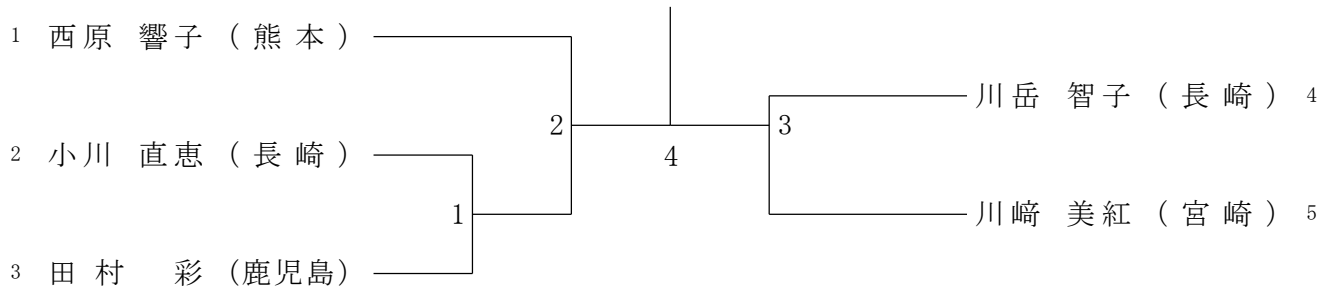

一般男子複 (MD)

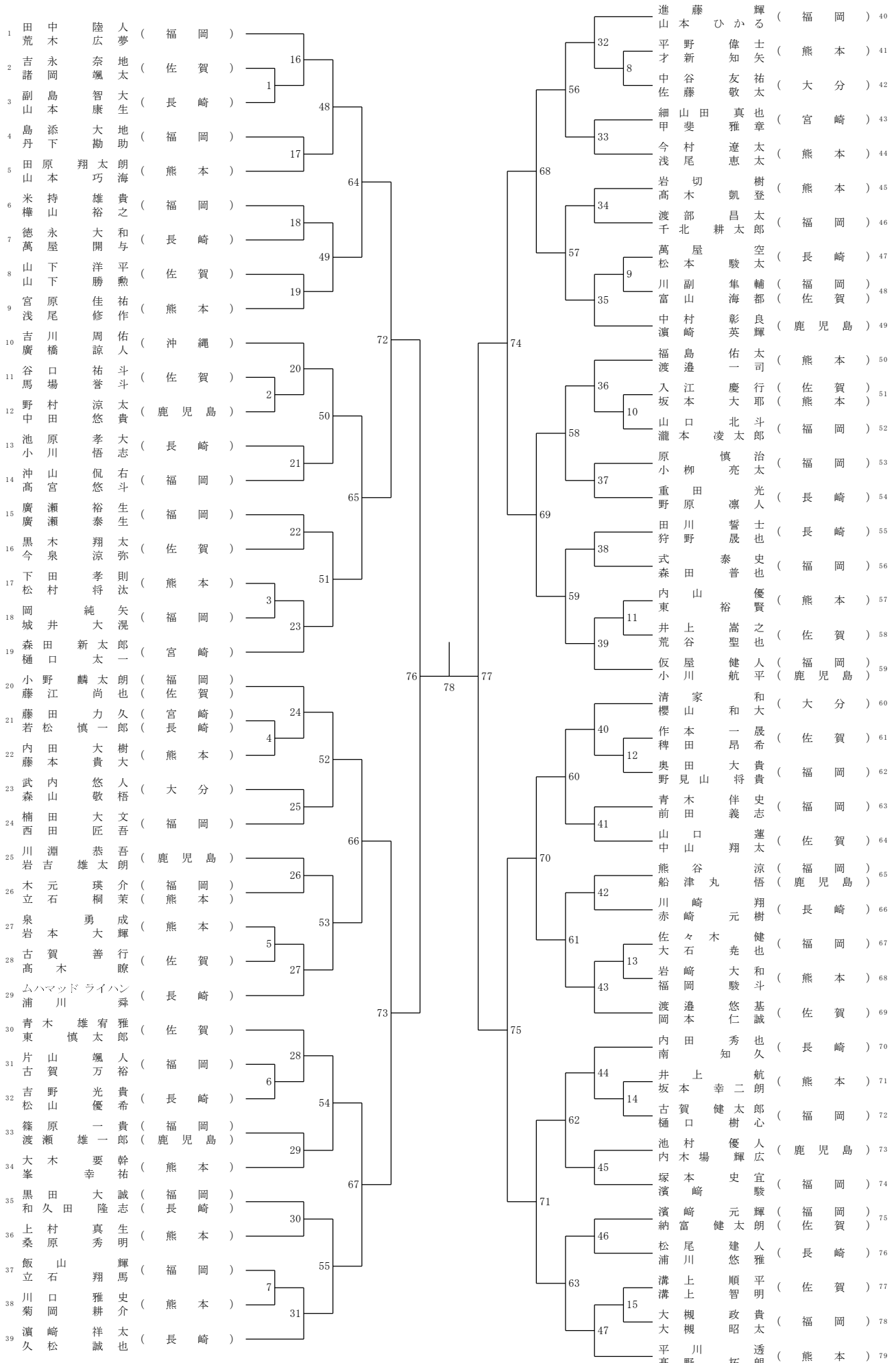

30歳以上男子複 (30MD)

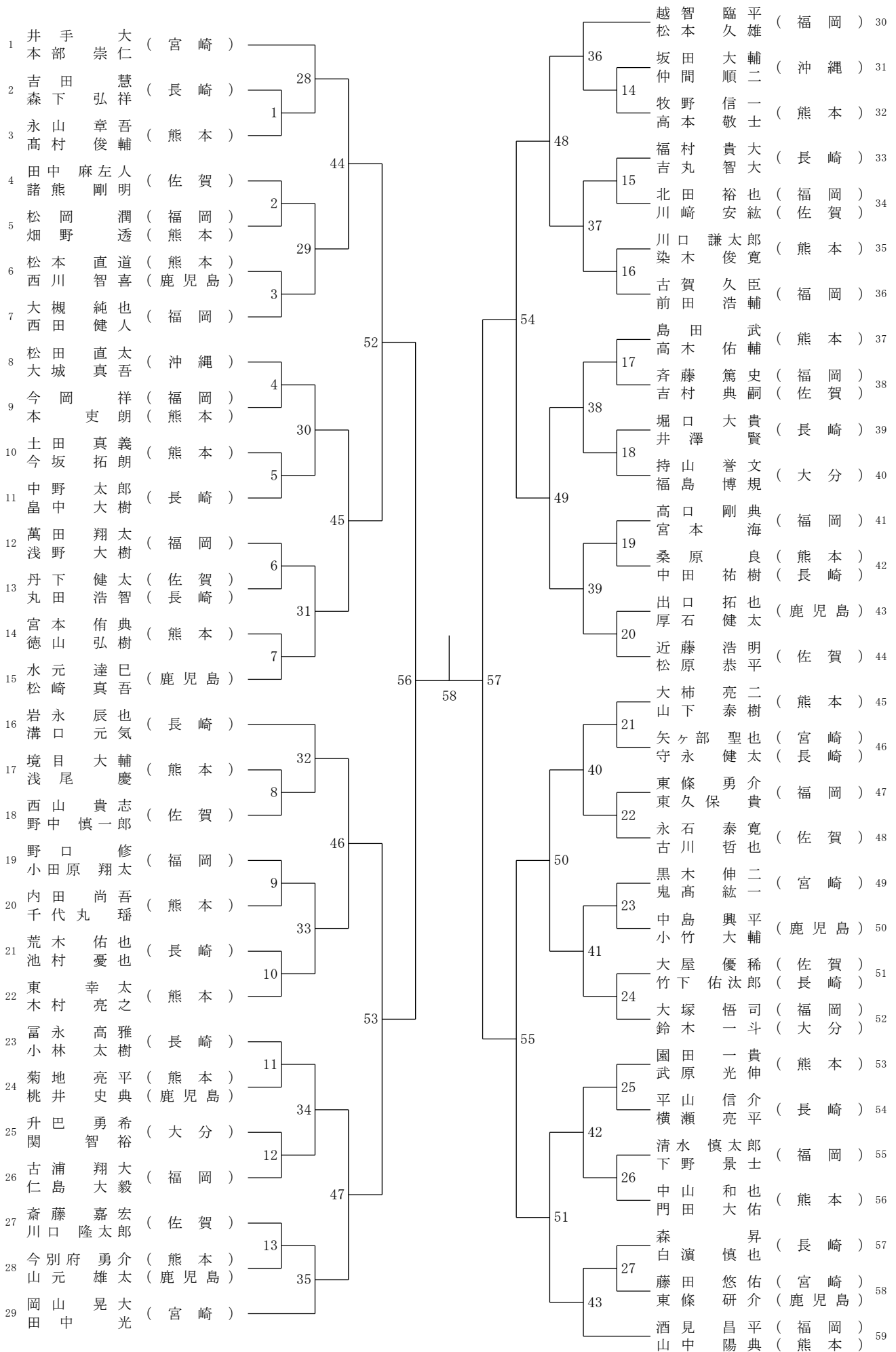



40歳以上男子複 (40MD)

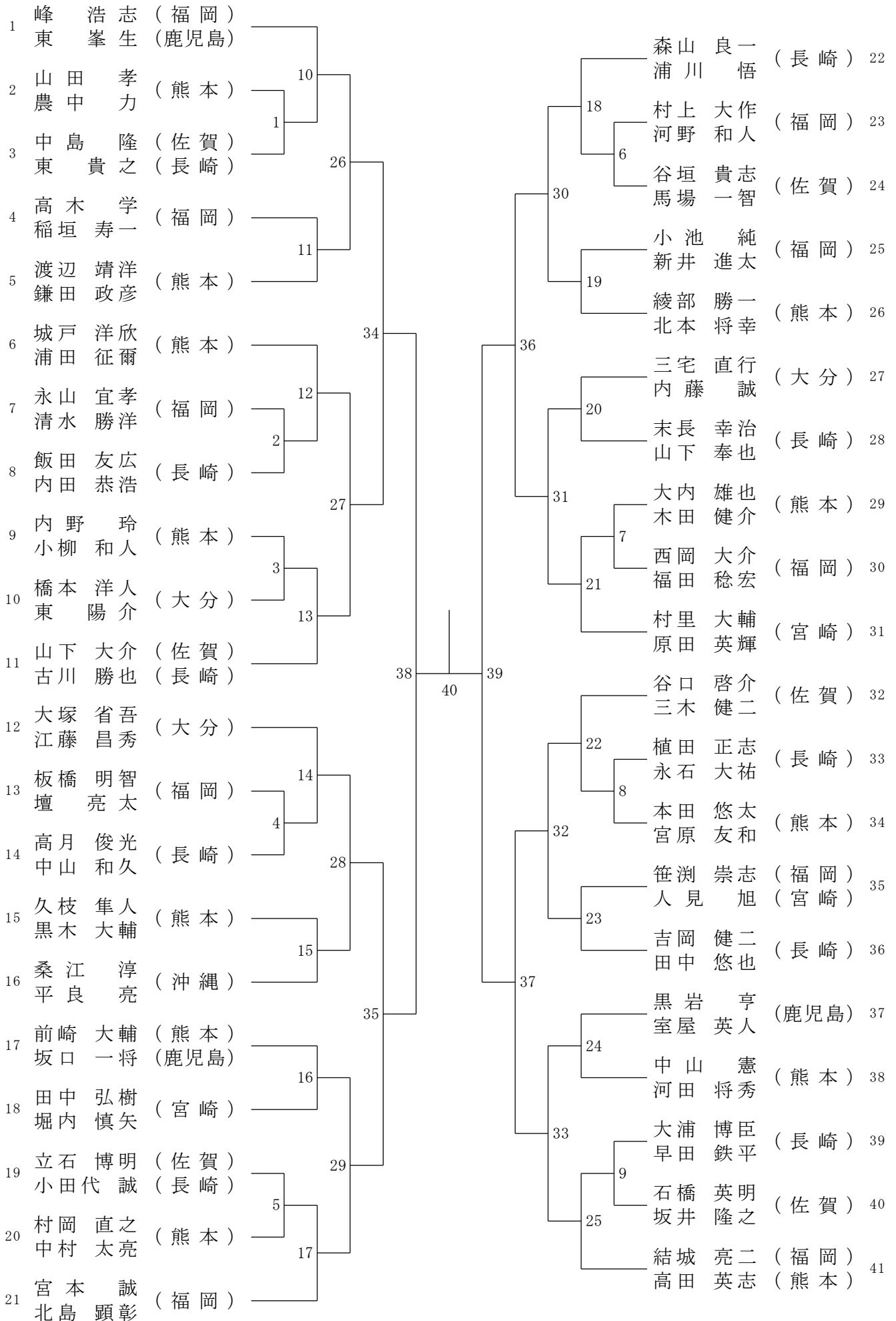

50歳以上男子複 (50MD)

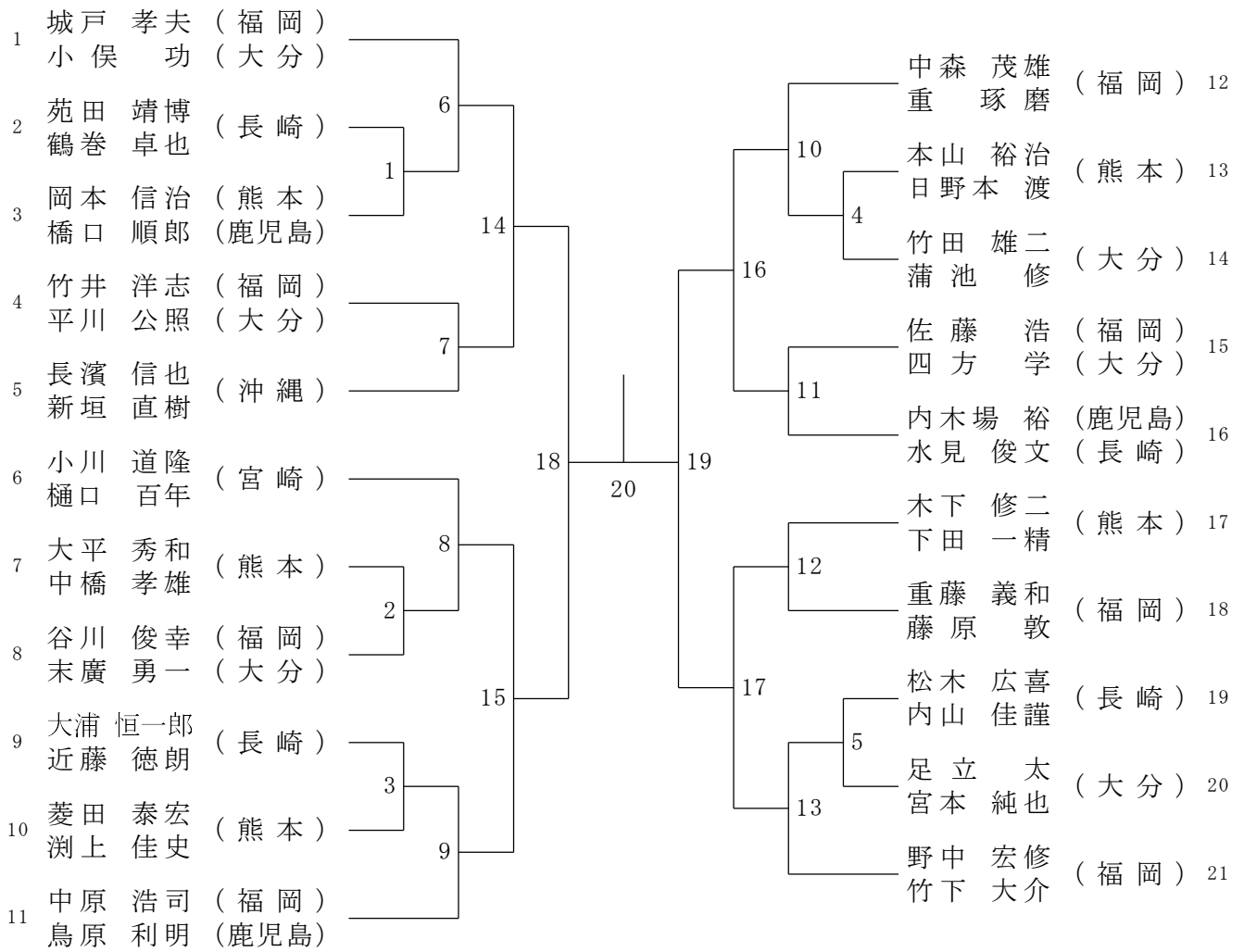

55歳以上男子複 (55MD)

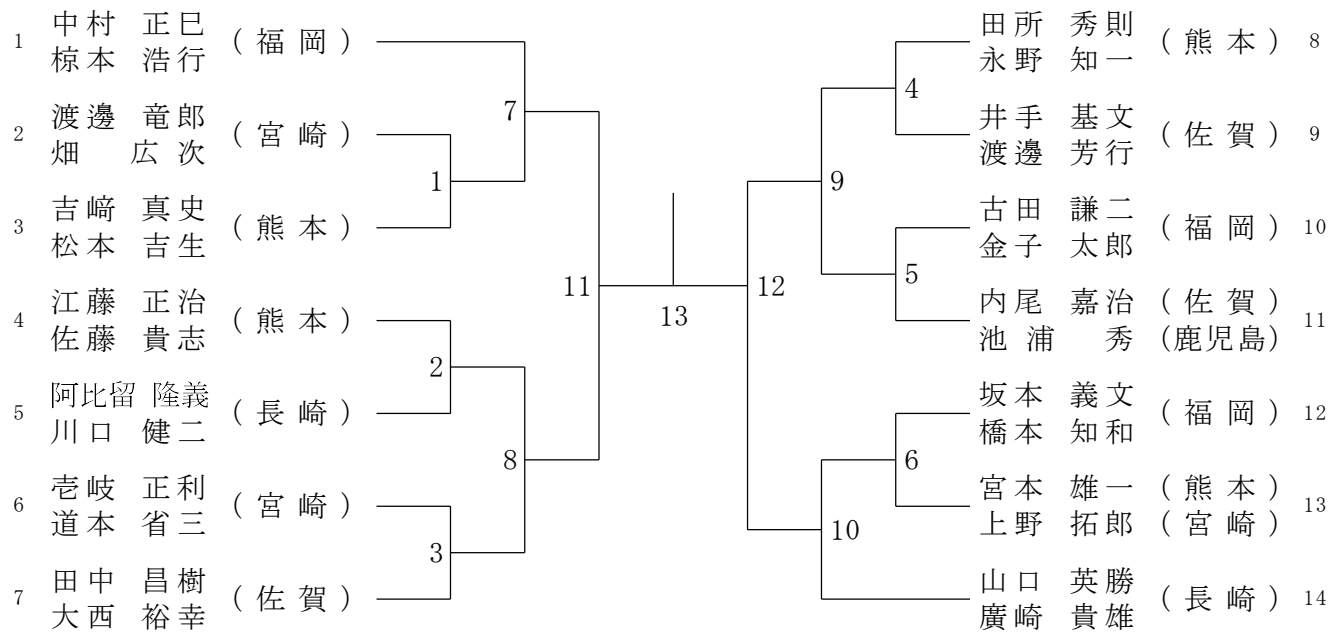

60歳以上男子複 (60MD)

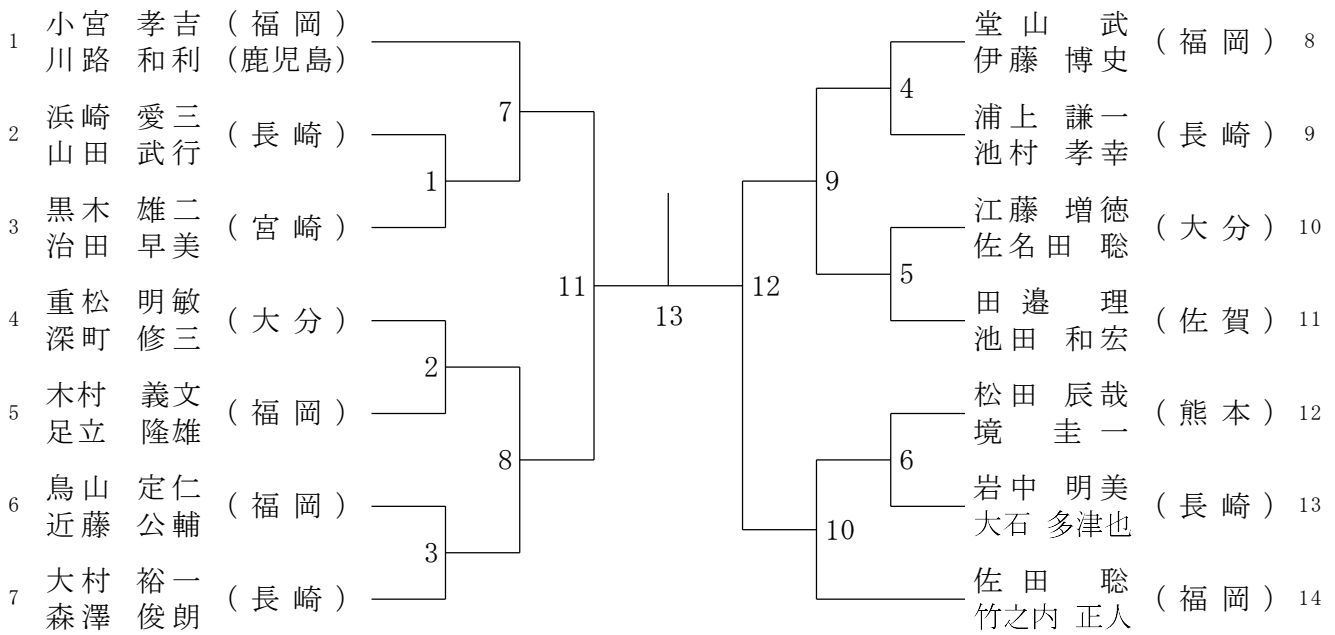

65歳以上男子複 (65MD)

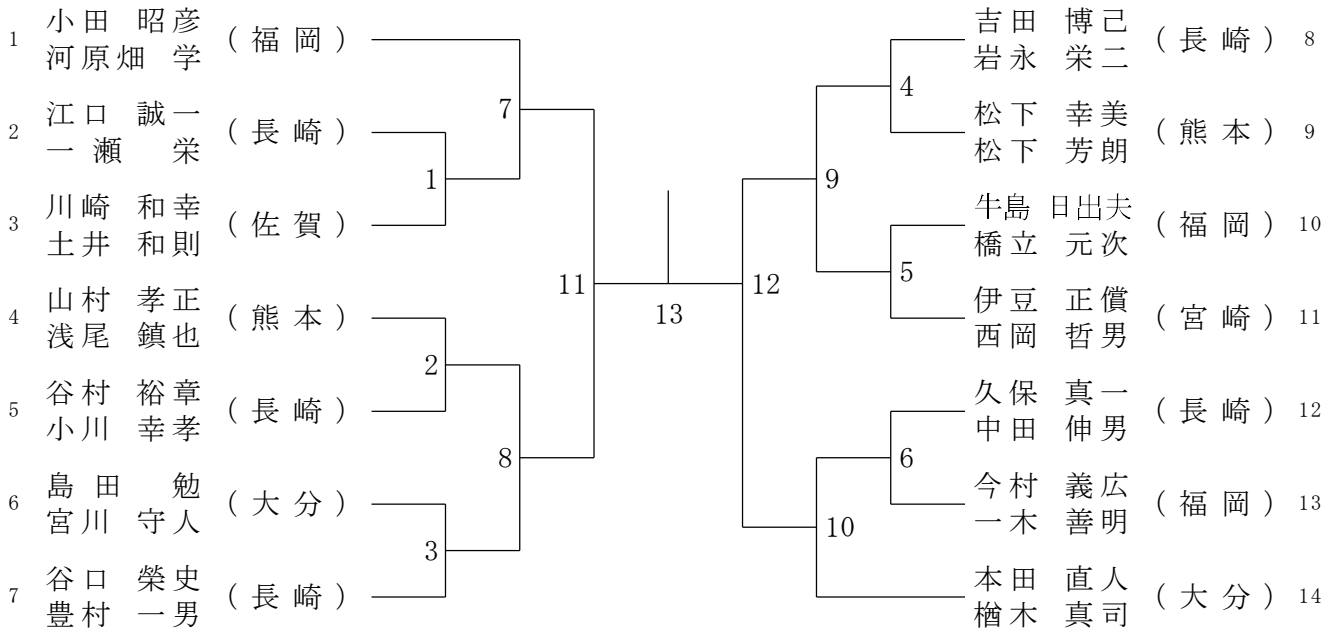

70歳以上男子複 (70MD)

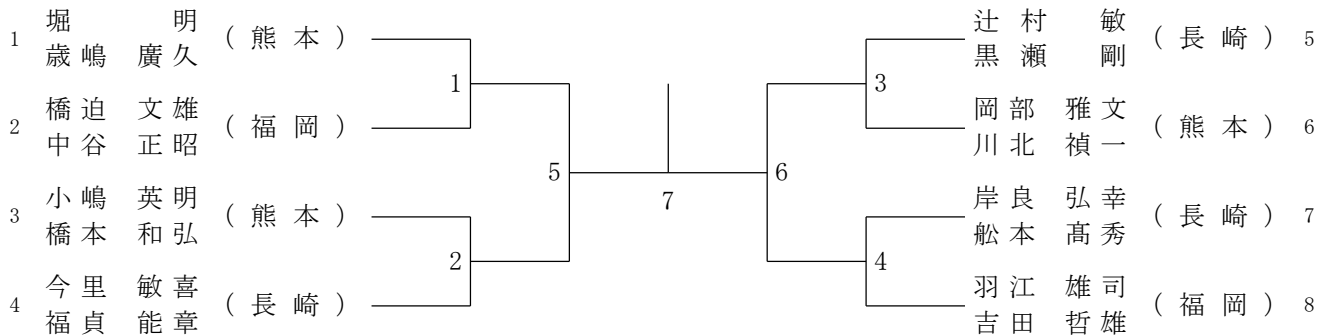

一般女子複 (WD)

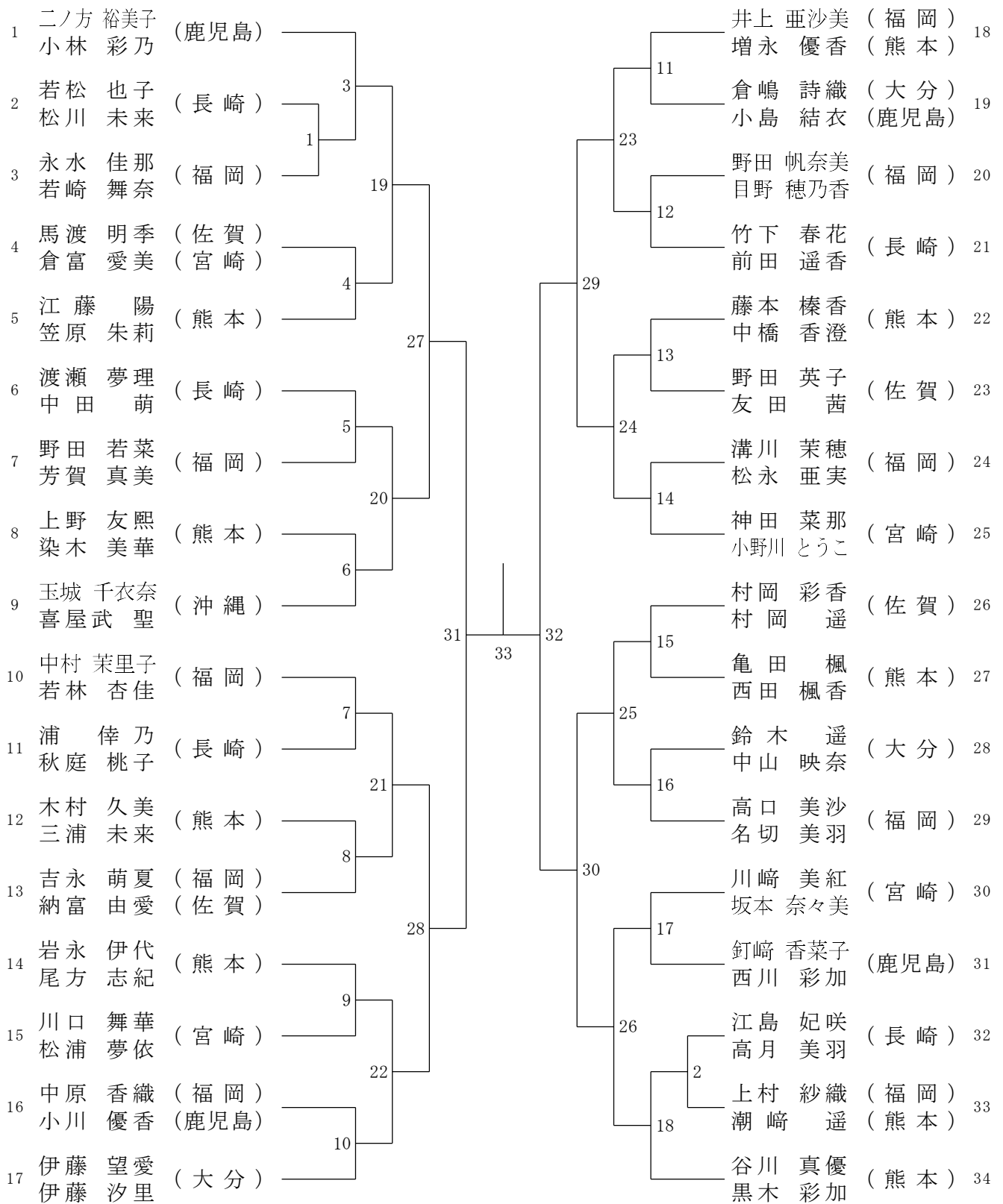

30歳以上女子複（30WD）

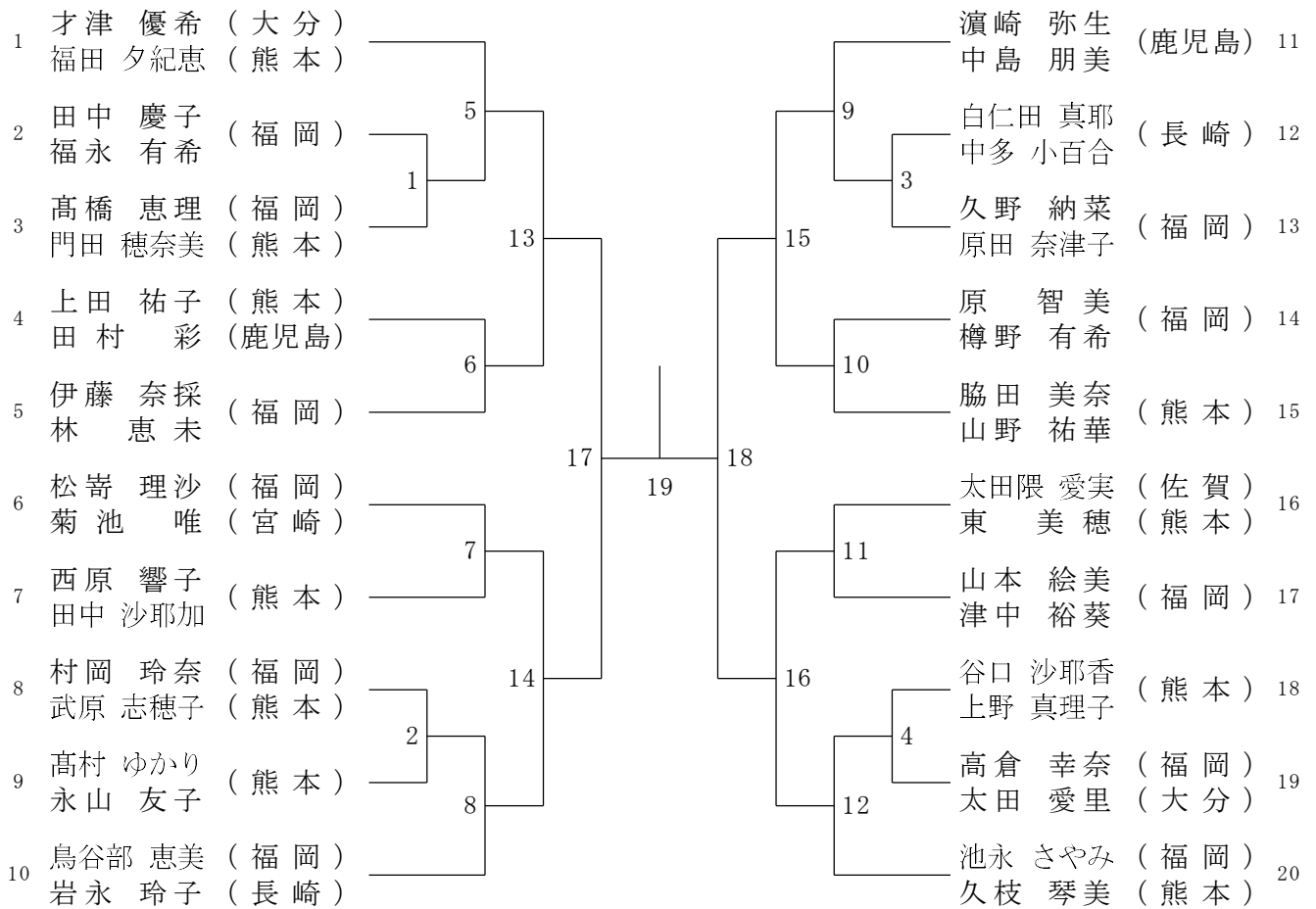

40歳以上女子複（40WD）

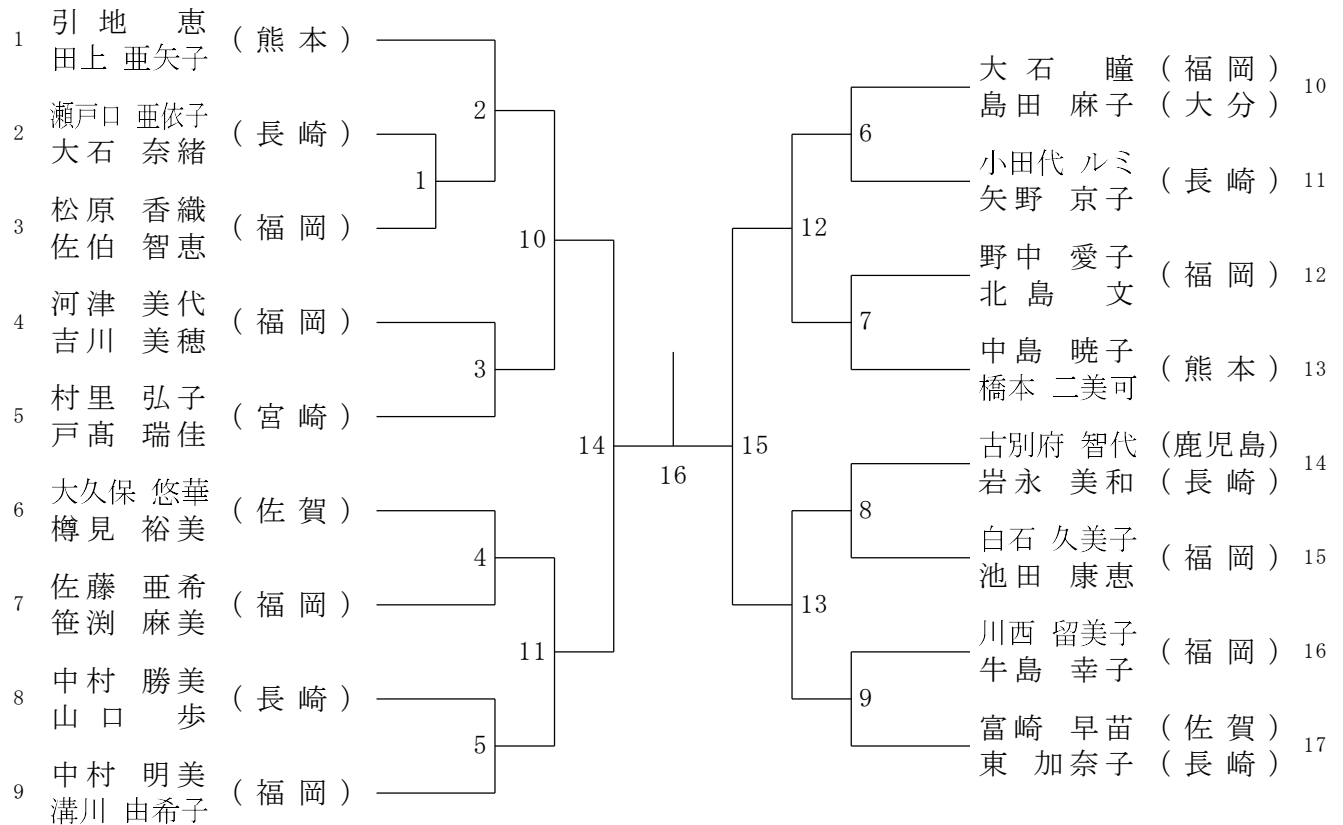

50歳以上女子複 (50WD)

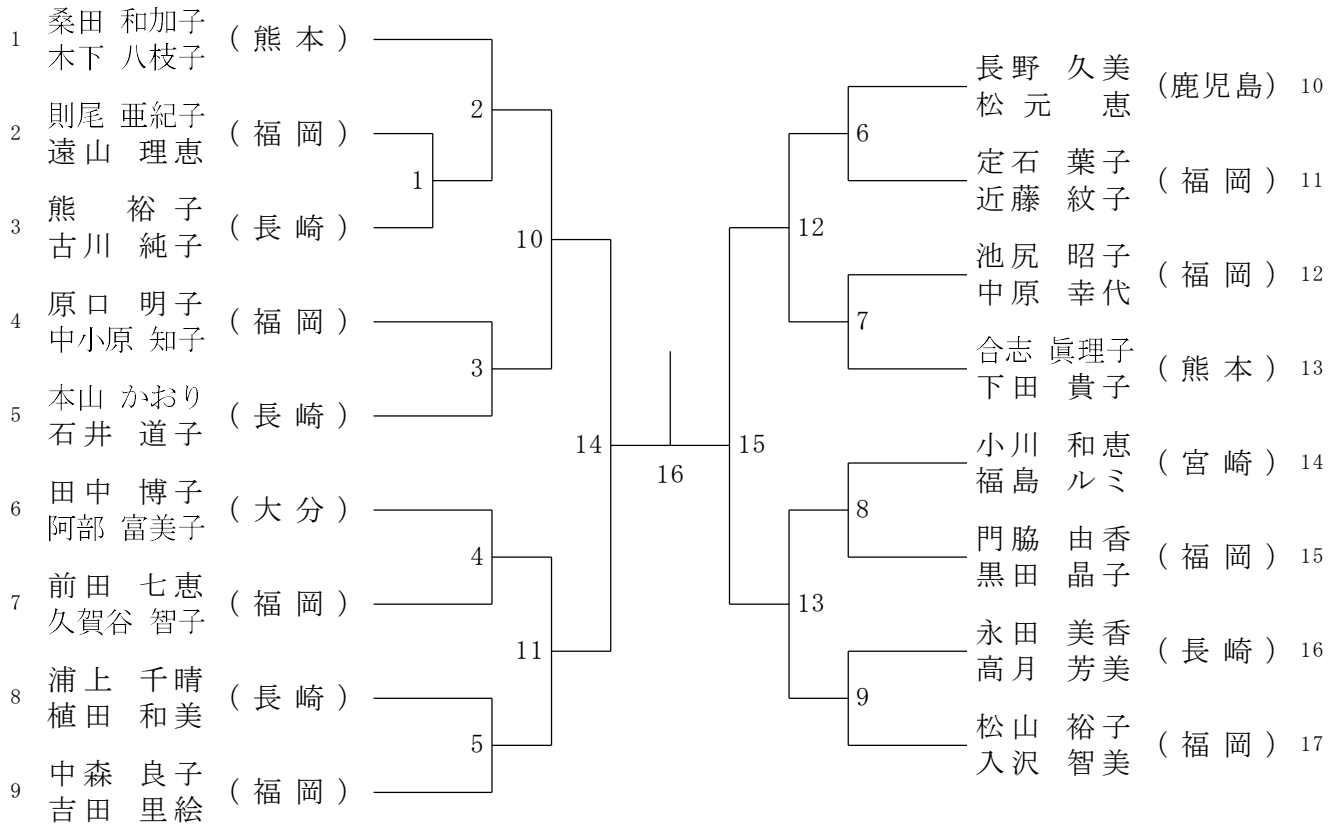

55歳以上女子複 (55WD)

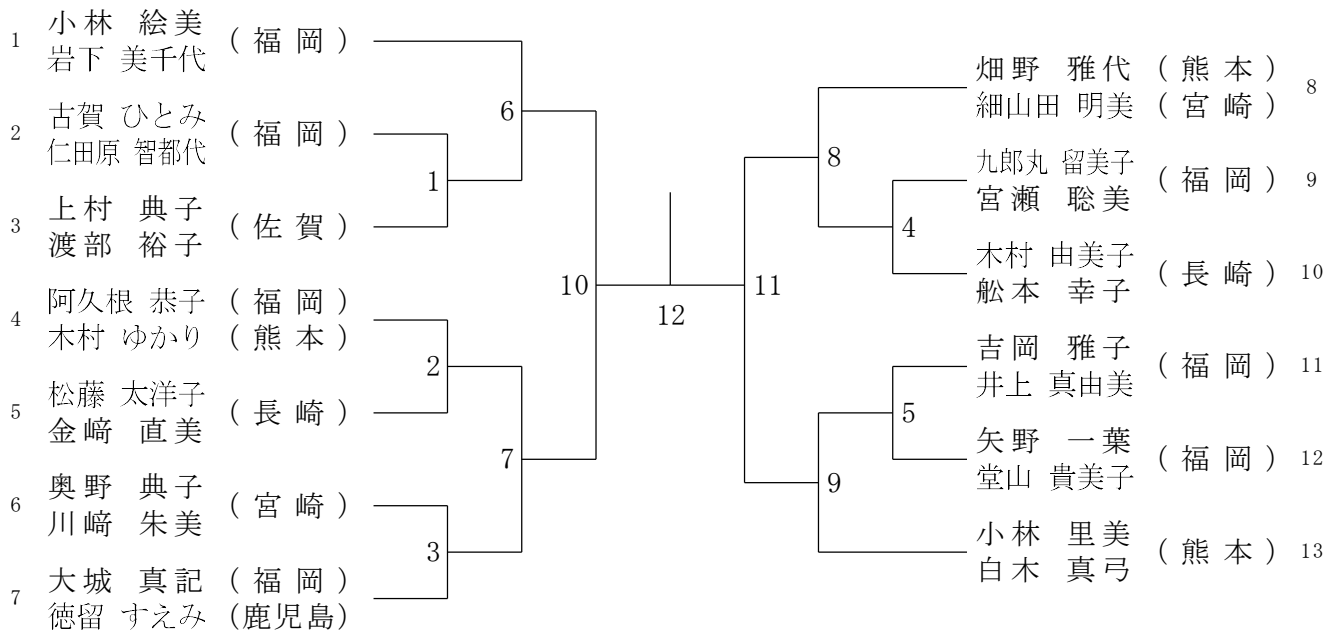

一般混合複 (XD)

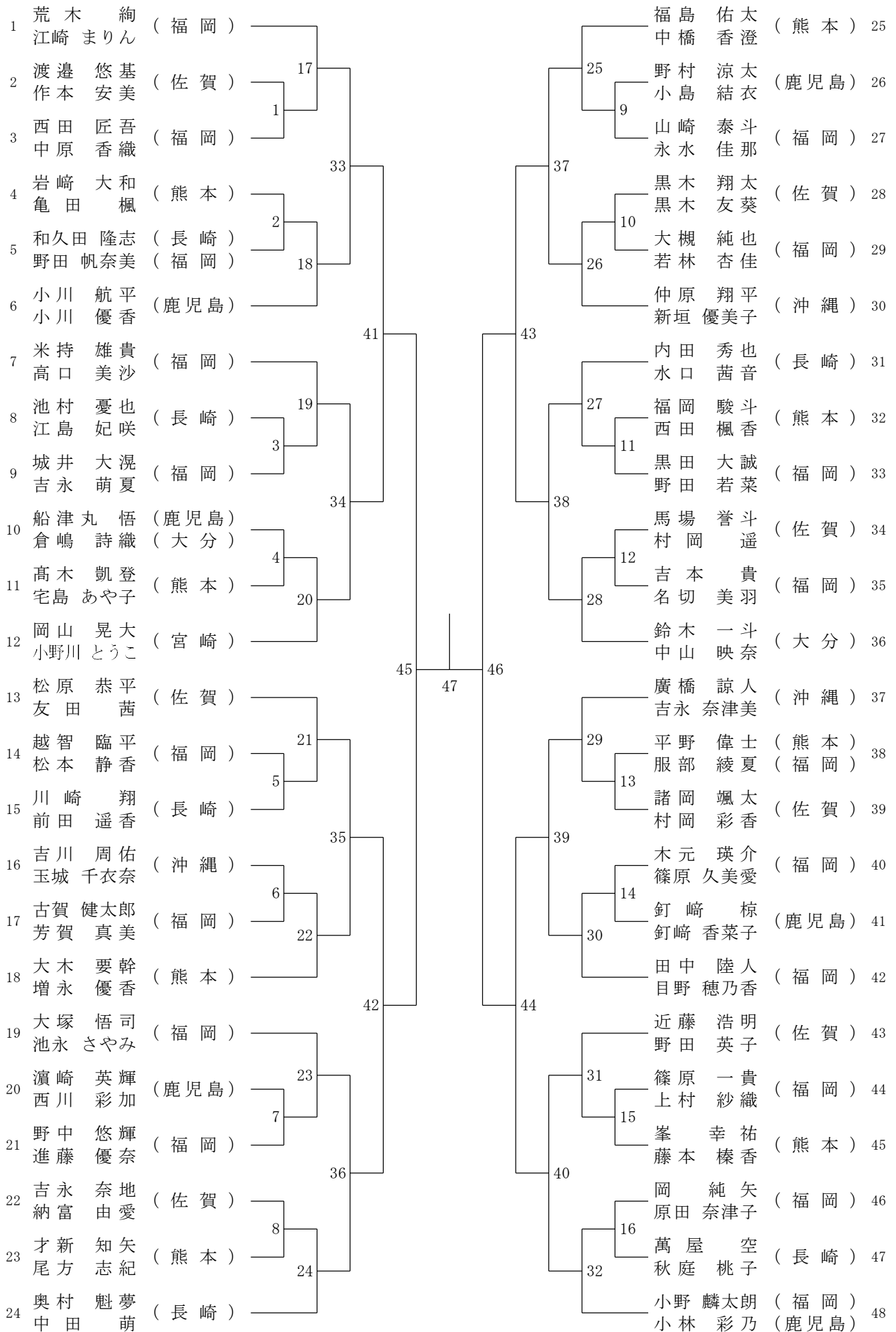

30歳以上混合複 (30XD)

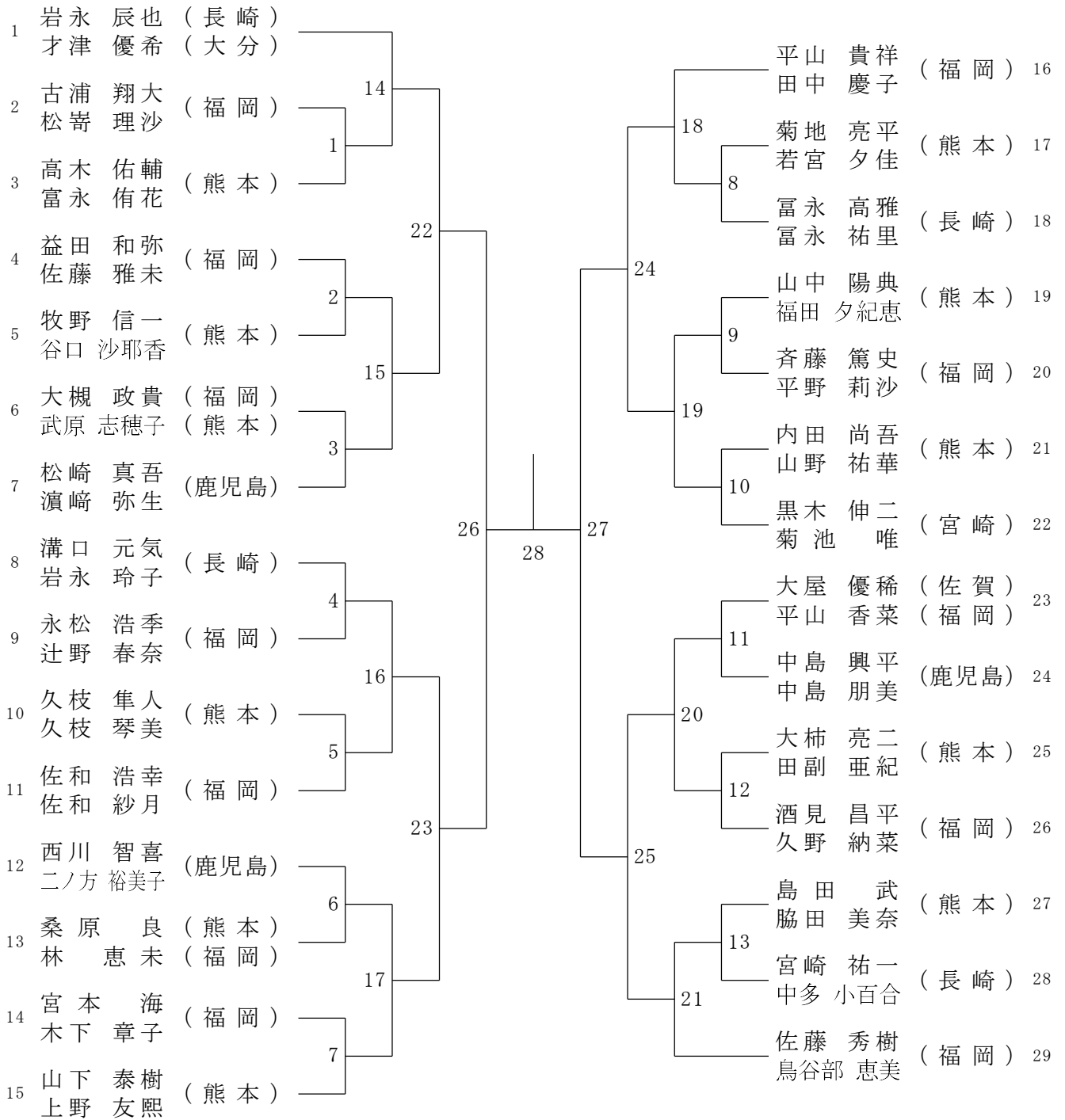



40歳以上混合複 (40XD)

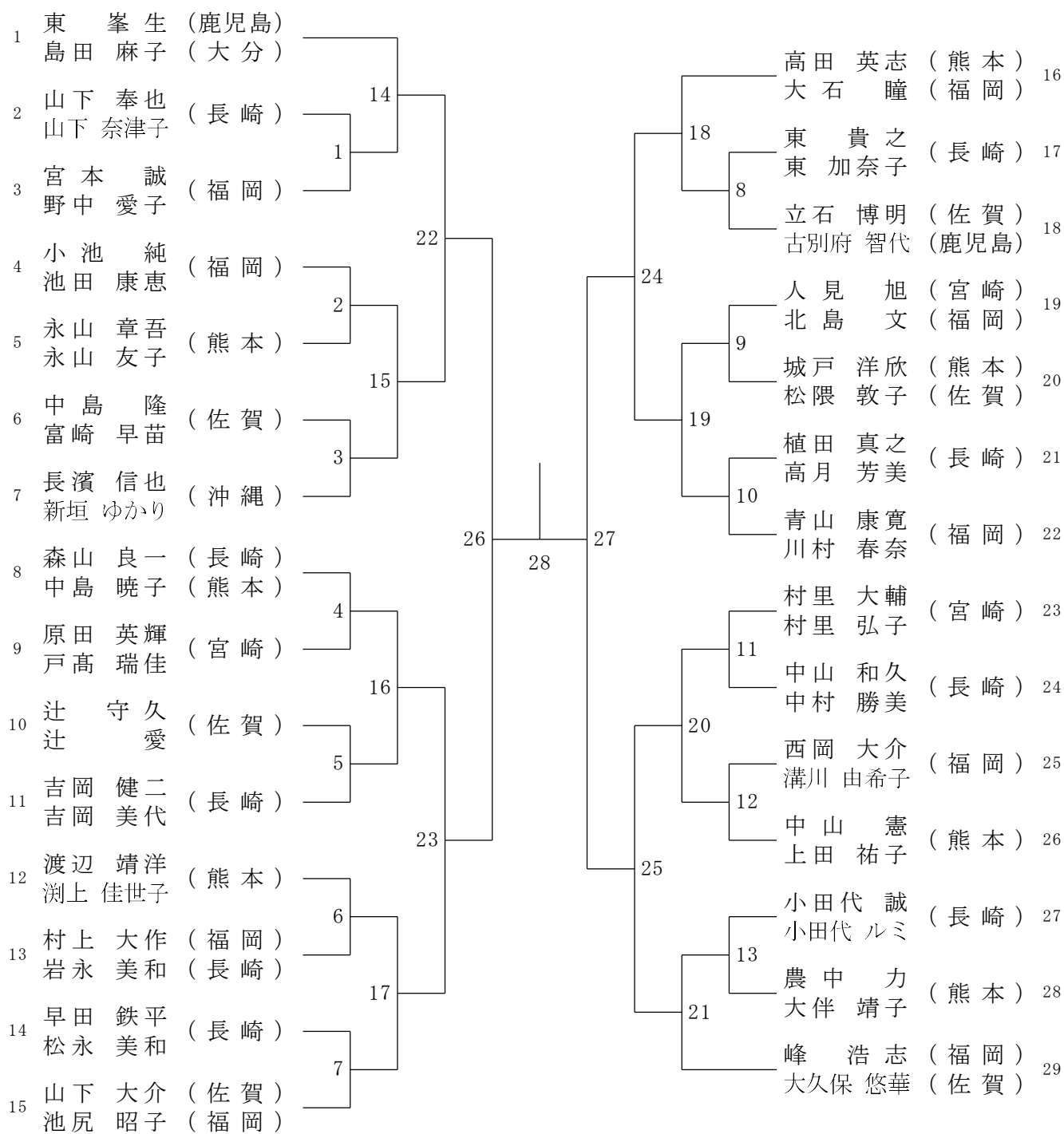

50歳以上混合複 (50XD)

